

TEXFRAME

PERFIL TF80

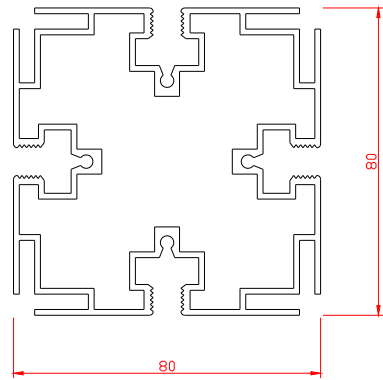
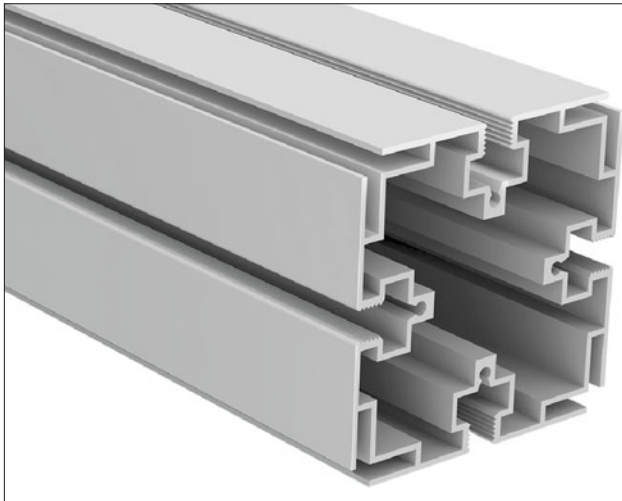

PESO g/m 2.840

Perfil cuadrado de 80x80 mm. realizado en aluminio anodizado con guías en todos sus ángulos para fijar tejidos por todas sus caras, se unen entre si a inglete o a testa mediante escuadras especiales. La forma mas sencilla para construir Stands, Paredes, Displays, Photocall, Torretas, etc... Destacar su fácil cambio de gráficas y su fácil Montaje, Transporte y Almacenaje.



TEXFRAME

CATALOGO TECNICO PERFIL TF80



CONECTOR CON PINZA DE UNION

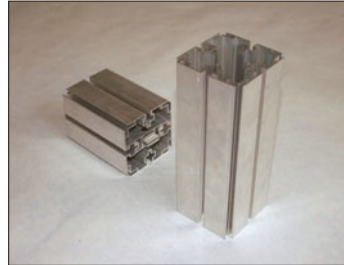

UNION A TESTA CON CONECTOR

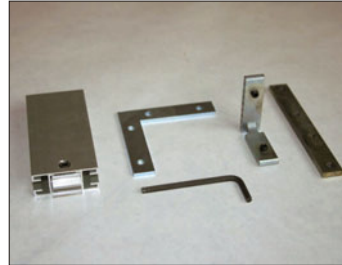

PIEZAS DE CONEXION



ANCLAJE DE FOCOS



ANGULO A INGLETE

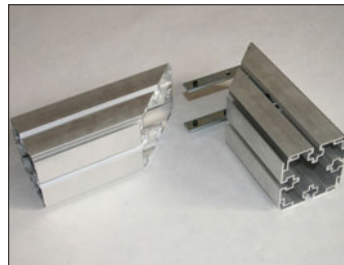

CONEXION ANGULO A INGLETE

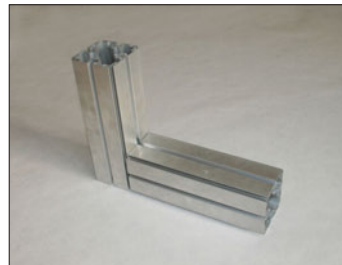

ANGULO A TESTA

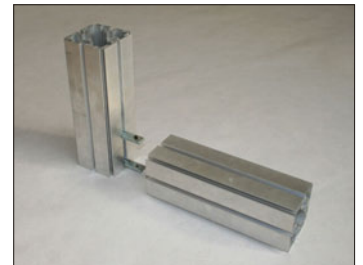

CONEXION ANGULO A TESTA

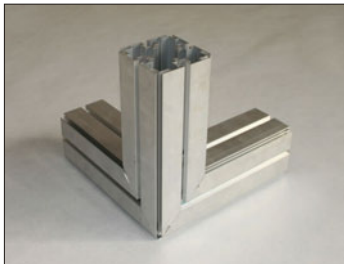

DOBLE ANGULO A INGLETE



DOBLE ANGULO A TESTA

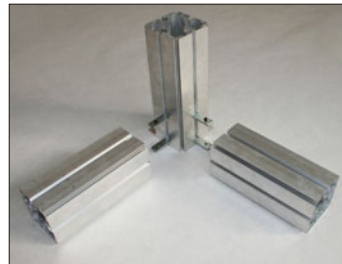

CONEXION DOBLE ANGULO

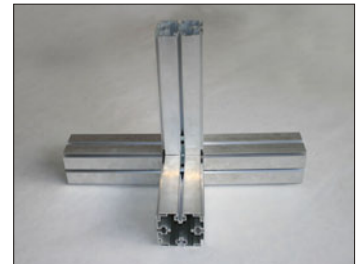

UNION EN SERIE

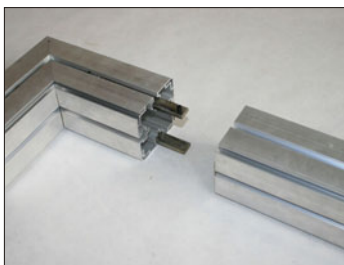

UNION PERFIL AL ANGULO



UNION PERFIL AL ANGULO

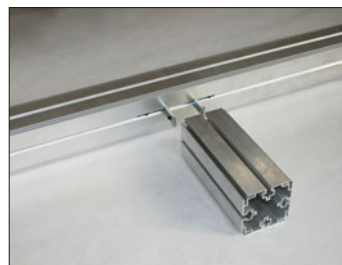

UNION INTERMEDIA



ILUMINACION POR LED



TEXTIL POR DENTRO



TEXTIL POR FUERA



ESTANTES Y MOSTRADOR



PORTA BANNERS Y VITRINAS

TEXFRAME

EJEMPLOS DE STANDS CON PERFIL TF80



Stand de 3x2 m.

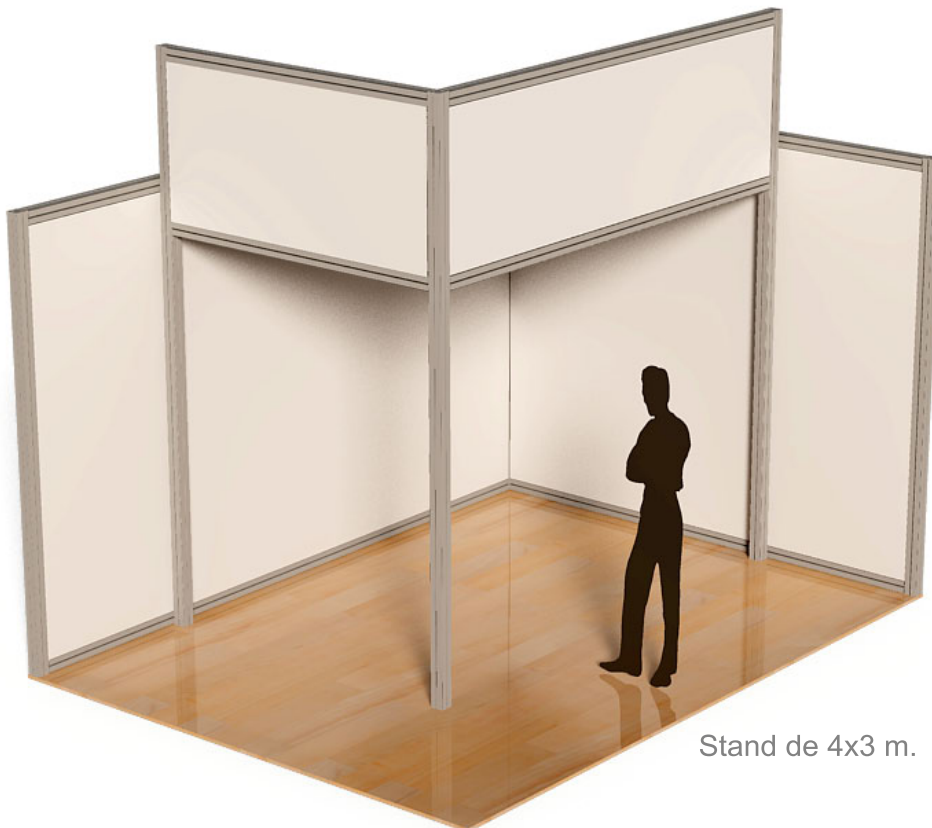

Stand de 4x3 m.

Estos son tan solo algunos ejemplos, podemos realizar cualquier diseño de stand

TEXFRAME

EJEMPLOS DE STANDS CON PERFIL TF80

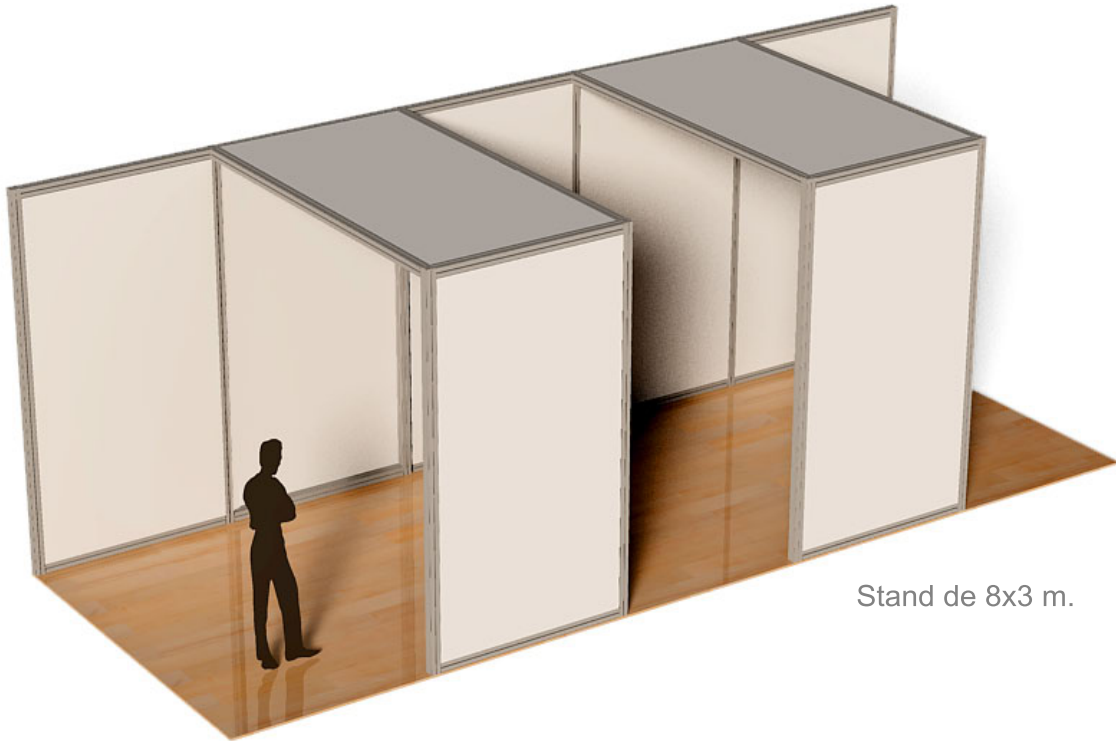

Stand de 8x3 m.

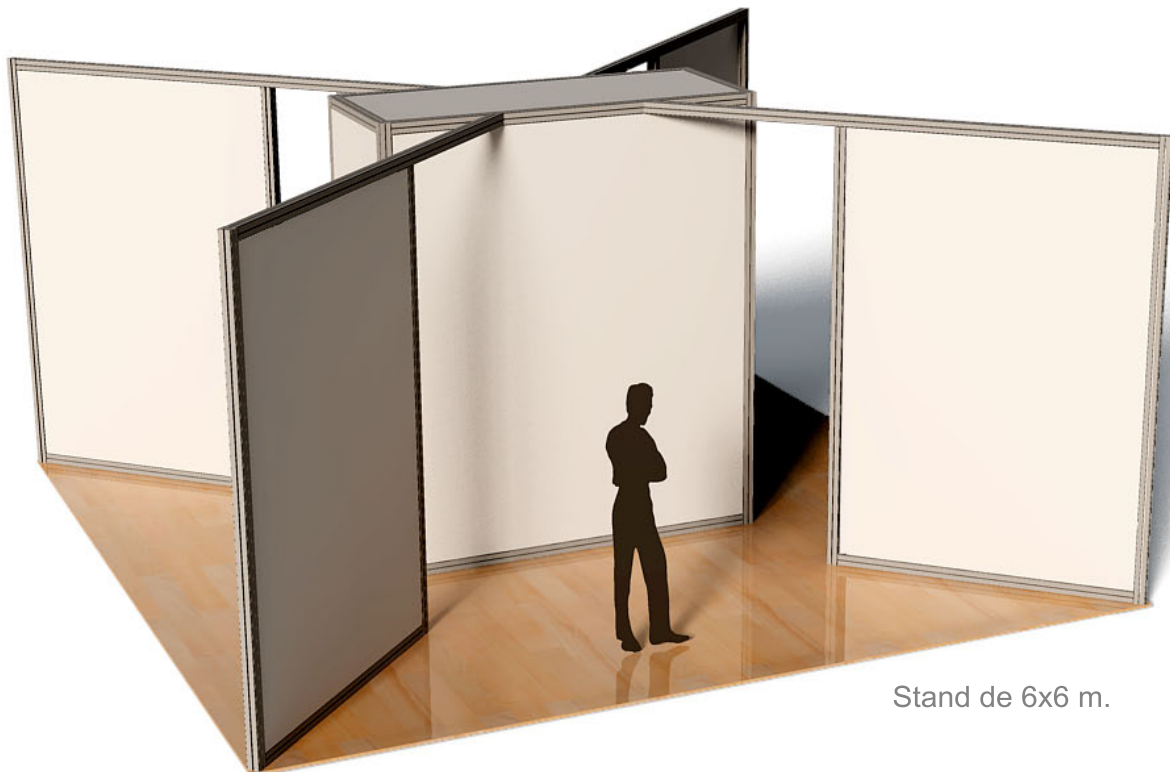

Stand de 6x6 m.

Estos son tan solo algunos ejemplos, podemos realizar cualquier diseño de stand

TEXFRAME

EJEMPLOS DE STANDS CON PERFIL TF80

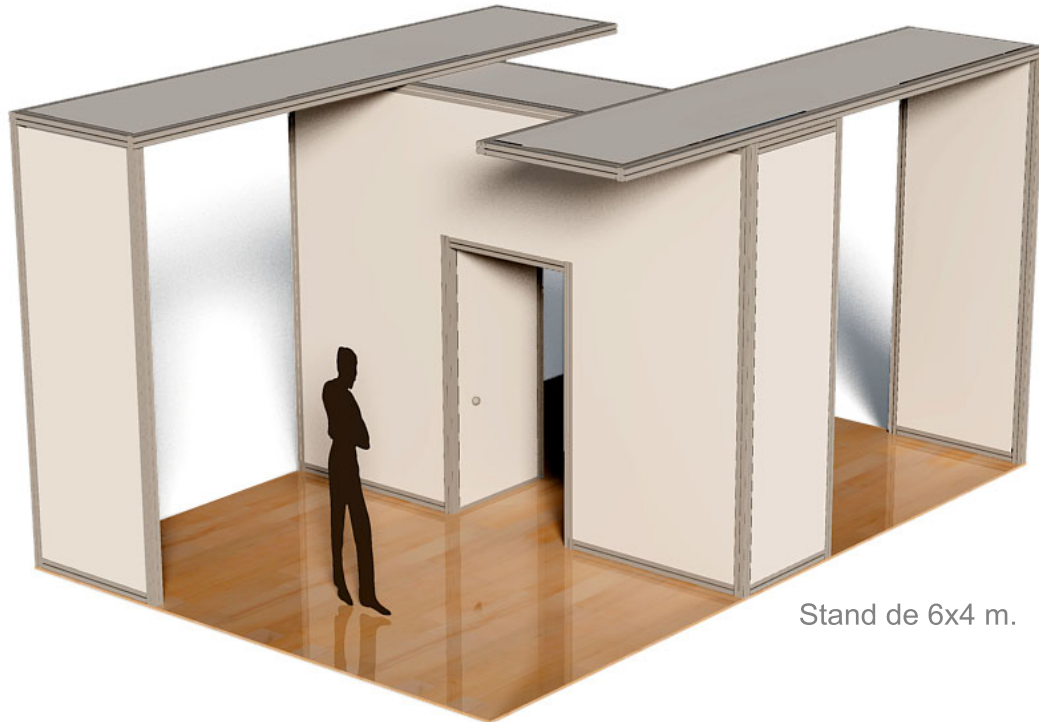

Stand de 6x4 m.

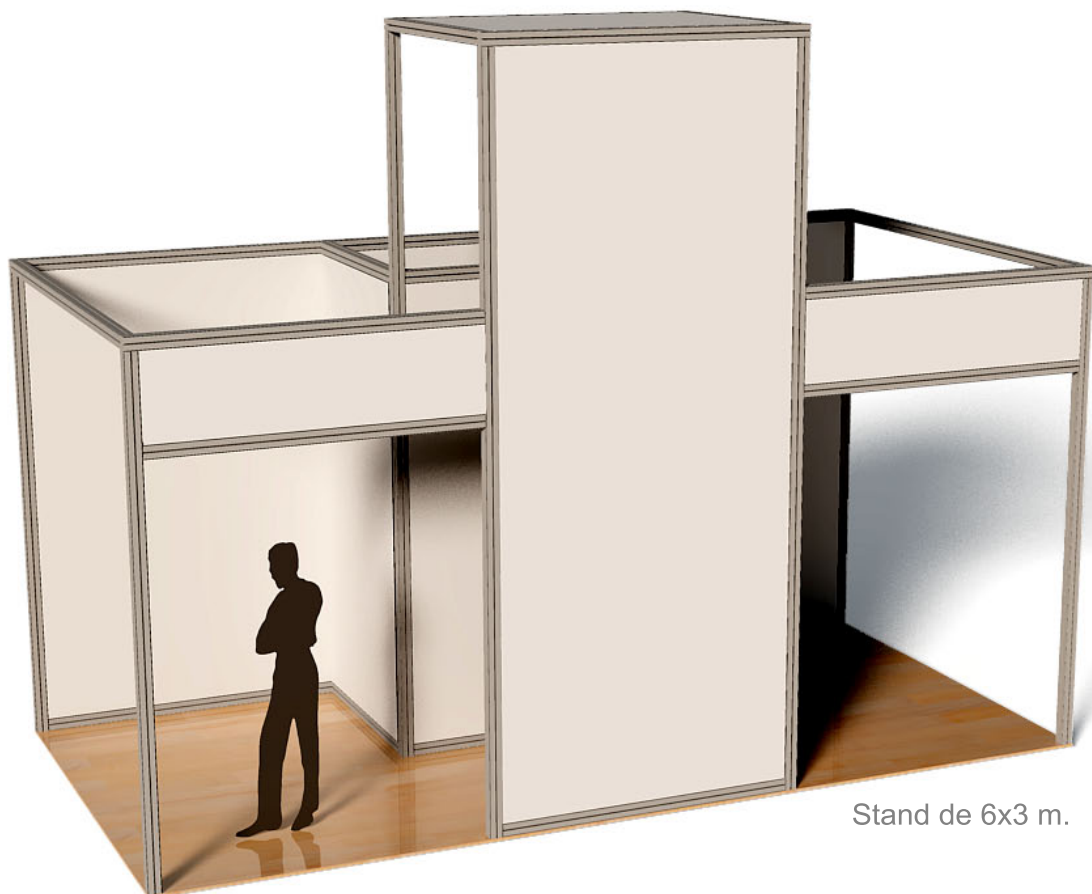

Stand de 6x3 m.

Estos son tan solo algunos ejemplos, podemos realizar cualquier diseño de stand